

Audio Amplifier Specialist (AAS)

ICE Amp



---

Final Report

---

Document: Final_Report.pdf	<b>Final Report ASS – Ice Amp</b>	
Date: 03/12/2013		
Rev: 01		
Page 2 of 22		

#### REVISION HISTORY AND APPROVAL RECORD

Revision	Date	Purpose
0	03/12/2013	Document creation
1	03/12/2013	Document modification by Adrià Romero
2	5/12/2013	Document modification by Eva Julián
3	12/12/2013	Document modification by Carlos Labella
4	15/12/2013	Document modification by Joan Marimon
5	17/12/2013	Document revision

#### DOCUMENT DISTRIBUTION LIST

Name	E-mail
Group member 1: Julián Ortín, Eva	ejulian93@hotmail.com
Group member 2: Labella De La Cruz, Carlos	labe89@gmail.com
Group member 3: Marimon Illana, Joan	jmarimon93@gmail.com
Group member 4: Romero López, Adrià	adriaromero@outlook.com
Professor 1: Bragós Bardia, Ramon	rbb@eel.upc.edu
Professor 2: García Hernández, Miguel Jesús	miguel.j.garcia@upc.edu

WRITTEN BY:		REVIEWED AND APPROVED BY:	
Date	03/12/2013	Date	17/12/2013
Name	Joan Marimon Illana	Name	Adrià Romero López
Position	Docum. Resp.	Position	Project leader

## 0. CONTENTS

0.	Contents .....	3
1.	Document scope .....	4
2.	Time plan updated .....	5
3.	System design documentation .....	7
4.	System implementation documentation.....	15
5.	System characterization.....	18
6.	Budget .....	19
7.	Conclusions .....	21
8.	Reflection document .....	22

Document: Final_Report.pdf	<b>Final Report ASS – Ice Amp</b>	
Date: 03/12/2013		
Rev: 01		
Page 4 of 22		

## 1. DOCUMENT SCOPE

First we will begin showing the client our real Time Plan updating the old one and taking into account some delays and changes that we have experimented.

After that we will attach the system documentation and explain the design of the system and why we use these specific components.

We will show the behavior and working of the circuits using all the schematics and simulations we have done.

We will show how it is all implemented and characterized. Furthermore, we will explain the tests that we have realized to verify that the amplifier satisfies the specifications.

Later, we will talk about the economic side of the project. We show you the budget where there is computed the cost of the components plus the employee's payment.

At the end of the document we will explain our team conclusions and thoughts reached while we have been doing the project.



























Document: Final_Report.pdf	<b>Final Report</b> <b>ASS – Ice Amp</b>	
Date: 03/12/2013		
Rev: 01		
Page 5 of 22		

## 2. TIME PLAN UPDATED

When the different blocks were joined, we realized that the output signal was very different comparing with the study of each block separately. There were components that act with enough differences to the theory that made us to analyze all the parts separately to discover what was the part of the circuit that makes that all works different and destroy the shape of the output signal. To improve the quality of our signal we have to analyze each part, step by step, to know what was happened. That's why we need a month to analyze the circuit.

When the most of the corrections were done, two persons of the team start with the improvement. In our team, everybody knows all the steps done by the others, if someone was blocked; the other persons of the team were able to help him.

For that, the real Time Plan was (next page):

	Nombre	Duración	Inicio	Terminado	Predecesores	Nombres del Recurso
1	 <b>Amplifier Behavioral Modeling Integration</b>	2,667...	9/10/13 8:00	9/10/13 17:00		
2	Triangular Signal Generator	2,667...	9/10/13 8:00	9/10/13 17:00		Adrià Romero
3	Input filter amplifier & Offset amplifier	2,667...	9/10/13 8:00	9/10/13 17:00		Joan Marimon
4	Signal comparator	2,667...	9/10/13 8:00	9/10/13 17:00		Carlos Labella
5	Low pass filter	2,667...	9/10/13 8:00	9/10/13 17:00		Eva Julian
6	 <b>Amplifier Blocks design &amp; characterization</b>	1,333...	16/10/13 8:00	16/10/13 13:00	1	
7	Triangular Signal Generator	1,333...	16/10/13 8:00	16/10/13 13:00	2	Adrià Romero;Joan Marimon
8	Input filter amplifier & Offset amplifier	1,333...	16/10/13 8:00	16/10/13 13:00	3	Joan Marimon;Adrià Romero
9	Signal comparator	1,333...	16/10/13 8:00	16/10/13 13:00	4	Carlos Labella;Eva Julian
10	Low pass filter	1,333...	16/10/13 8:00	16/10/13 13:00	5	Eva Julian;Carlos Labella
11	 <b>Blocks prototyping &amp; System Integration (mount each part sep...</b>	1,333...	23/10/13 8:00	23/10/13 13:00	6	
12	Triangular Signal Generator	1,333...	23/10/13 8:00	23/10/13 13:00	7	Adrià Romero;Eva Julian
13	Input filter amplifier & Offset amplifier	1,333...	23/10/13 8:00	23/10/13 13:00	8	Joan Marimon;Carlos Labella
14	Signal comparator	1,333...	23/10/13 8:00	23/10/13 13:00	9	Carlos Labella;Joan Marimon
15	Low pass filter	1,333...	23/10/13 8:00	23/10/13 13:00	10	Eva Julian;Adrià Romero
16	 <b>System prototyping &amp; analysis of prototype</b>	36 da...	6/11/13 8:00	27/11/13 11:00	11	
17	<input type="checkbox"/> <b>Analyze separately</b>	0,667...	6/11/13 8:00	6/11/13 10:00		
18	 Triangular Signal Generator	0,667...	6/11/13 8:00	6/11/13 10:00	12	Adrià Romero;Carlos Labella
19	 Input filter amplifier & Offset amplifier	0,667...	6/11/13 8:00	6/11/13 10:00	13	Joan Marimon;Eva Julian
20	 Signal comparator	0,667...	6/11/13 8:00	6/11/13 10:00	14	Carlos Labella;Adrià Romero
21	 Low pass filter	0,667...	6/11/13 8:00	6/11/13 10:00	15	Eva Julian;Joan Marimon
22	<input type="checkbox"/> <b>Analyze together on the protoboard</b>	35,33...	6/11/13 10:00	27/11/13 11:00	18;19;20;21	
23	  Make corrections for each component to improve the signal shape (Da...	0,333...	6/11/13 10:00	6/11/13 11:00	18;19;20;21	Eva Julian;Carlos Labella;Joan Marimon;Adrià Romero
24	  Make corrections for each component to improve the signal shape (Da...	1 day?	13/11/13 8:00	13/11/13 11:00	18;19;20;21	Eva Julian;Carlos Labella;Joan Marimon;Adrià Romero
25	  Make corrections for each component to improve the signal shape (Da...	1 day?	20/11/13 8:00	20/11/13 11:00	18;19;20;21	Eva Julian;Carlos Labella
26	  Make corrections for each component to improve the signal shape (Da...	0,5 d...	27/11/13 8:00	27/11/13 11:00	18;19;20;21	Adrià Romero;Joan Marimon
27	  <b>Solder on the plate</b>	24,33...	4/12/13 8:00	18/12/13 11:00	22	<b>Eva Julian;Adrià Romero</b>
28	 Design of the system	1 day	4/12/13 8:00	4/12/13 11:00	22	Eva Julian;Adrià Romero
29	 Solder the circuit	1 day?	11/12/13 8:00	11/12/13 11:00	28	Eva Julian;Adrià Romero
30	 <input type="checkbox"/> <b>System improvements</b>	24,33...	4/12/13 8:00	18/12/13 11:00	22	<b>Carlos Labella;Joan Marimon</b>
31	 Accessory elements implementation	1 day?	4/12/13 8:00	4/12/13 11:00	22	Carlos Labella;Joan Marimon
32	 Study the verification protocol and the measures	1 day?	11/12/13 8:00	11/12/13 11:00	31	Carlos Labella;Joan Marimon
33	 Accessory elements design	1 day?	18/12/13 8:00	18/12/13 11:00	32	Carlos Labella;Joan Marimon
34	  <b>Finishing tasks</b>	0,5 d...	19/12/13 8:00	19/12/13 9:30	29;33	Eva Julian;Carlos Labella;Joan Marimon;Adrià Romero
35	 Final Design Review. Results presentation.EVALUATION II	0,5 d...	19/12/13 9:30	19/12/13 11:00	34	Eva Julian;Carlos Labella;Joan Marimon;Adrià Romero



### 3. SYSTEM DESIGN DOCUMENTATION

In order to have an orientation about which values were the best for comply the specification list, we had used some simulation software that allows us to see the difference about choosing different parameters for sign treaty.

The first simulation software used was a script made on Matlab. On this script is possible to modify some basic parameters of class D signals, such as modulation shape, frequency, output filter and so on.

On this script fundamental parameters are set for get a modulation frequency of 250KHz, with a triangular wave carrier, and output filter with cutoff frequency of 20KHz.

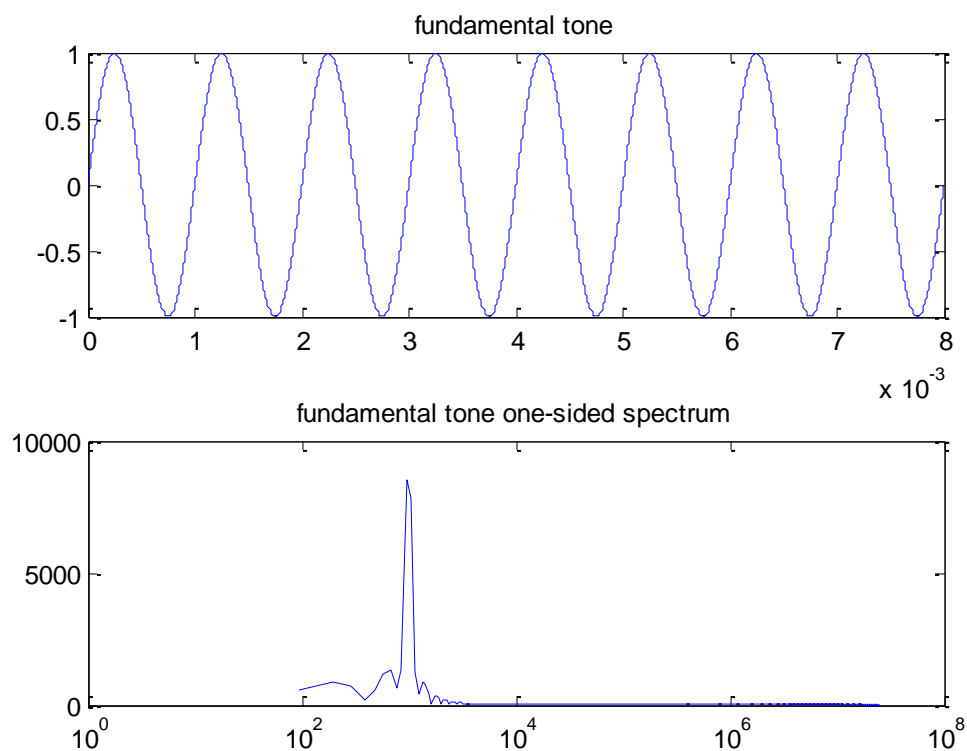

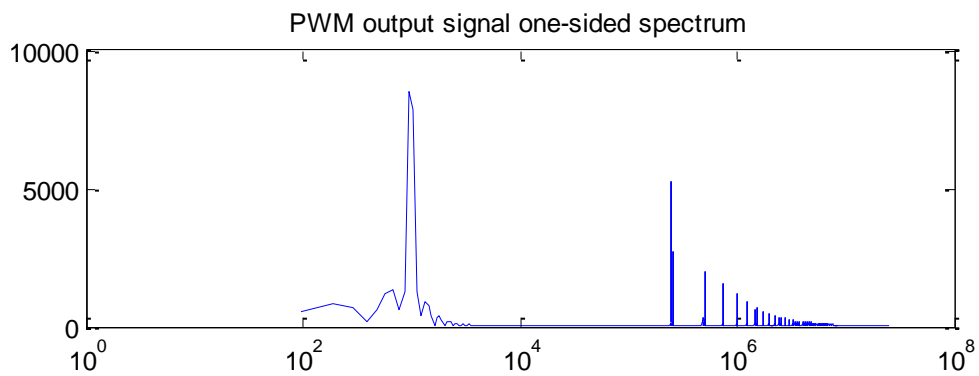
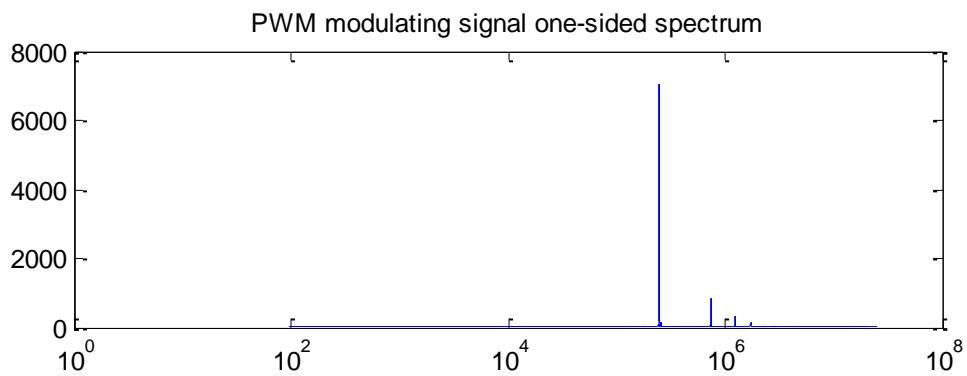
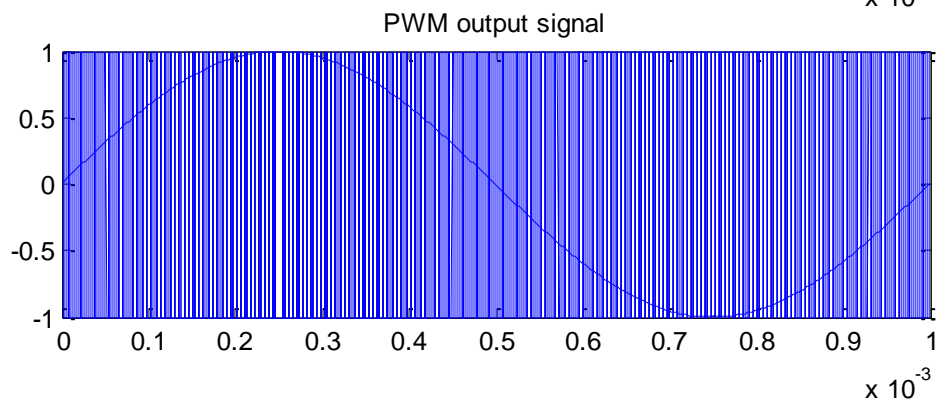
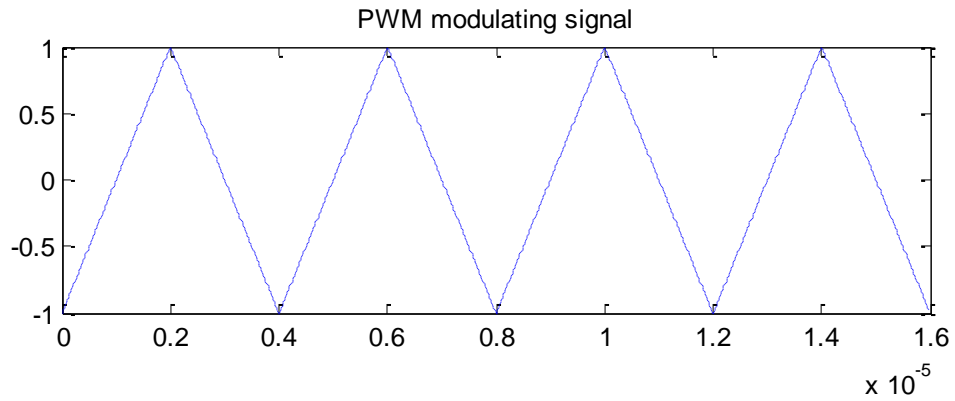



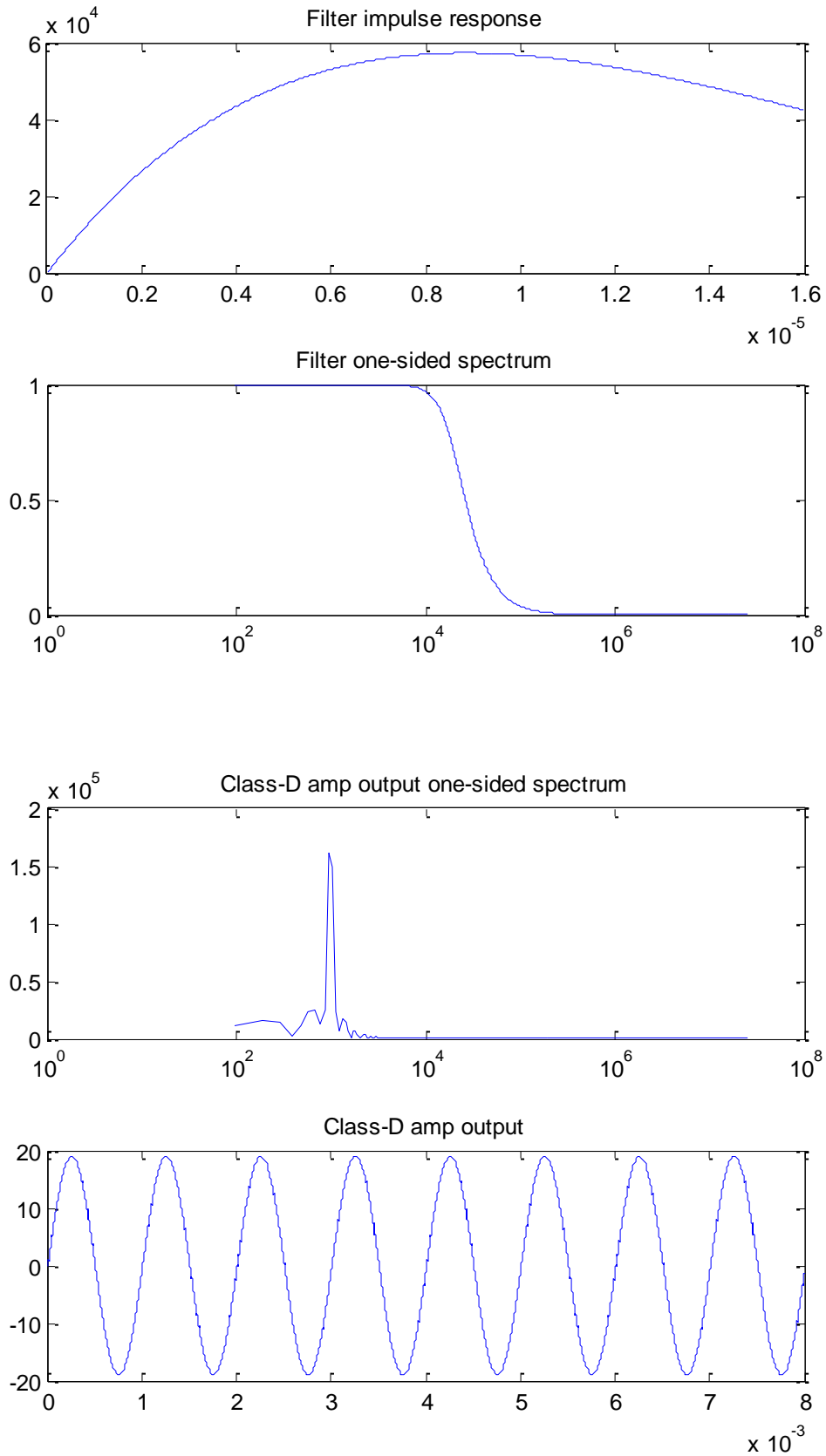

So at this point we can get a correct output signal after the low pass filter.



With these basic parameters selected, we can continue with the design with real components.

The first block diagram:

## Sub-block prototyping and characterization

---

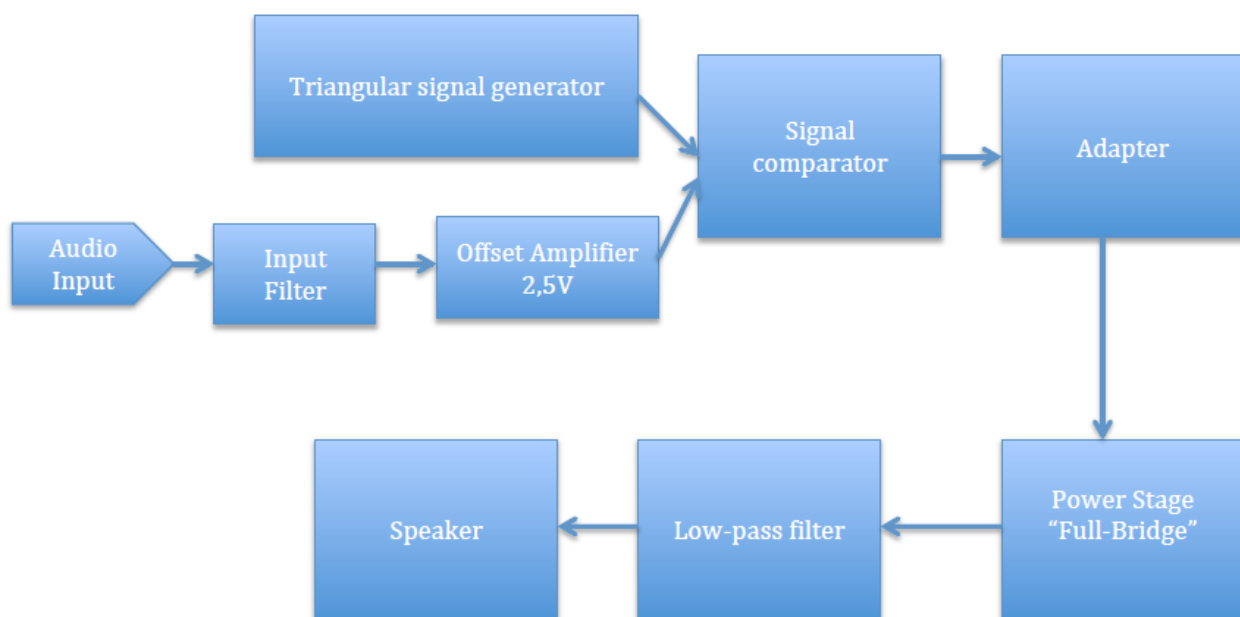



### -Triangular signal generator

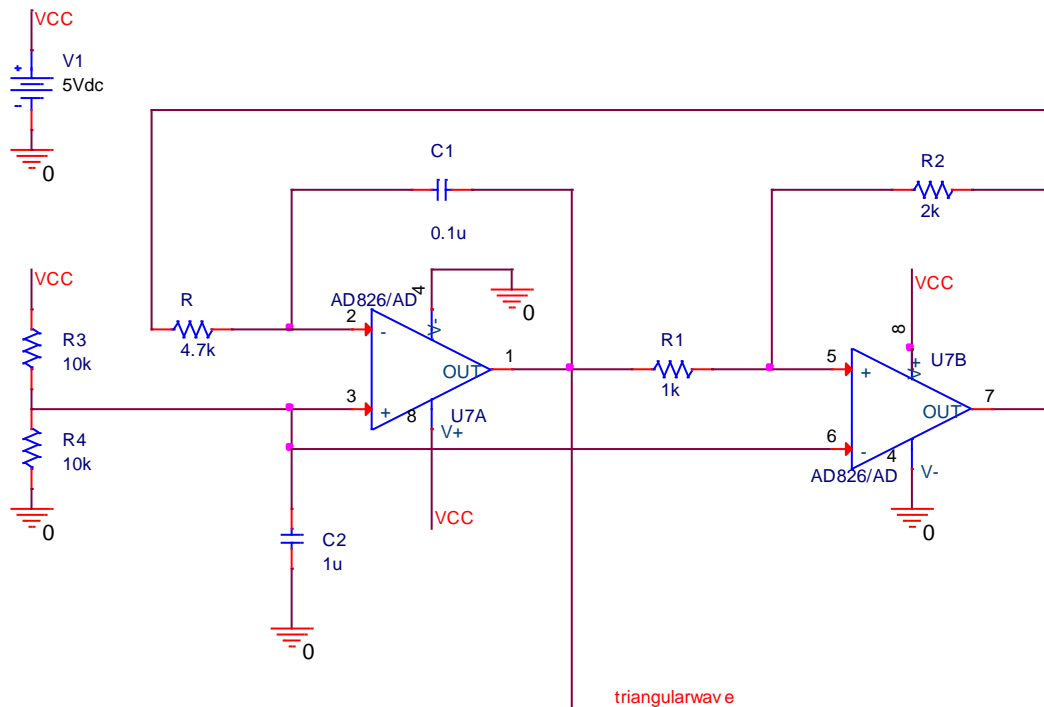

For the design of this block, we made use of the document MAXIM Application Note 3201 (<http://pdfserv.maximintegrated.com/en/an/AN3201.pdf>). At this point with real components selected, there was a little change over modulation frequency, due to output stage only works well under 200KHz, so our modulation frequency was established at 200KHz.

We need triangular wave with an average value of 2.5V (supply voltage 5V), and the amplitude of the triangular signal of around 3V.

PWM Modulation :

$$f = 200\text{KHz}$$

$$V_{TH} - V_{TL} = 3V$$

$$C_1 = 1\text{nF}$$

$$R_1 = 1\text{K}\Omega$$

$$VCC = 5V$$

AN 4362 equations :

$$f_{TMod} = \frac{R_2}{4RC_1R_1} \text{ with } R_2 < R_1$$

$$V_{TH} - V_{TL} = \frac{R_1}{R_2} VCC$$

$$V_{TH} - V_{TL} = \frac{R_1}{R_2} VCC \rightarrow 3V = \frac{1\text{K}\Omega}{R_2} 5V \rightarrow R_2 = 1,666 \text{K}\Omega$$

$$1,5\text{K}\Omega < R_2 < 1,8\text{K}\Omega \rightarrow 3,3V < V_{TH} - V_{TL} < 2,7V \quad (R_2 = 1,5\text{K}\Omega)$$

$$f_{TMod} = \frac{R_2}{4RC_1R_1} \rightarrow 200 \text{KHz} = \frac{1,5\text{K}\Omega}{4 \cdot R \cdot 1\text{nF} \cdot 1\text{K}\Omega} \rightarrow R = 1875 \Omega$$

$$1,8\text{K}\Omega < R < 2,2\text{K}\Omega \rightarrow 208,3\text{KHz} < f_{TMod} < 170 \text{KHz} \quad (R = 1,8\text{K}\Omega)$$



### - Pre-amplifier block

The mean of this block is to increase audio input amplitude to a greater value to improve SNR, while processing signal, and set average value to 2,5V.

We want a gain of 10 and an input filter with cutoff frequency of 10Hz.

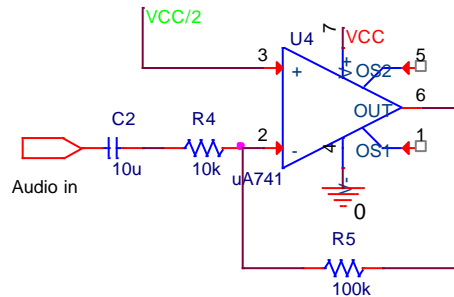

$$f_{in} = [20\text{Hz to } 20\text{KHz}]$$

$$V_{in} = [0\text{mV}_{pp} \text{ to } 200\text{mV}_{pp}]$$

$$C_1 = 10\ \mu\text{F}$$

$$VCC = 5\text{V}$$

$$f_{cutoff} = \frac{1}{R_4 C_4} \rightarrow 10\ \text{Hz} = \frac{1}{10\ \mu\text{F} \cdot R_4} \rightarrow R_4 = 10\ \text{K}\Omega$$

$$G = \frac{R_5}{R_4} \rightarrow 10 = \frac{R_5}{10\ \text{K}\Omega} \rightarrow R_5 = 100\ \text{K}\Omega$$

### - Comparator block

The comparator block is composed for one component. Have to compare output signal of pre-amplifier with triangular wave signal, and the output of comparator is the result of compare both signals.

The component that realizes this block has to be enough quick due to triangular wave signal is quick (200KHz).

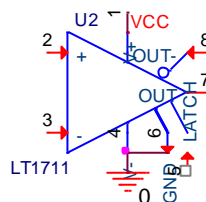

This component has been chosen because it has two outputs, normal output and inverted one. This makes easy the output stage attachment.



### -Output stage

This block is made only with a single component that integrates a full bridge stage, with previous stage to adapt input signals.

It works with the two outputs of the comparator block, the normal output and the inverted.

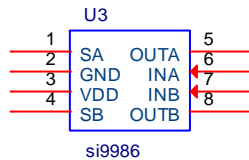

This component allows to feed the output signal with another supply source different from it supply, but in our case, this supply is the same.

### - Output filter block

The principal parameters of this block where decided at first simulation, but finally cut-off frequency was changed for let us some margin to accomplish bandwidth specifications.

Is an LC passive filter, a second order filter with theoretical no power dissipation, that allow us eliminate the triangular wave carrier and hold only audio component.

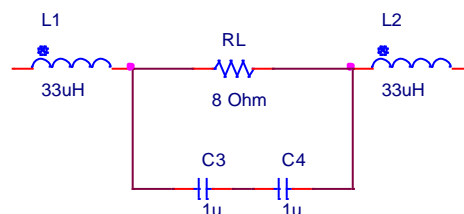

We made use of the document “Class-D LC Filter Design” (<http://www.ti.com/lit/an/sloa119a/sloa119a.pdf>) for the filter design.

Filter parameters :

$$f_{\text{Cut-Off}} = 30\text{KHz}$$

$$R_L = 8\Omega$$

$$Q = \frac{1}{\sqrt{2}}$$

$$L = L_1 = L_2$$

$$C = \frac{C_3}{2} = \frac{C_4}{2}$$

Document equations :

$$f_{\text{Cut-Off}} = \frac{1}{2\pi \cdot \sqrt{L \cdot 2 \cdot C}}$$

$$Q = \frac{R_L}{2} \cdot \sqrt{\frac{2 \cdot C}{L}}$$



ecuacions solve system of two unknowns :

$$30 \text{ KHz} = \frac{1}{2\pi\sqrt{L \cdot 2 \cdot C}} \rightarrow L = (30 \text{ KHz} \cdot 2\pi)^2 \cdot 2 \cdot C$$

$$0.707 = \frac{8}{2} \cdot \sqrt{\frac{2 \cdot C}{L}} \rightarrow C = \frac{L}{2} \left(\frac{0.707}{4}\right)^2$$

$$L = (30 \text{ KHz} \cdot 2\pi)^2 \cdot 2 \cdot \frac{L}{2} \left(\frac{0.707}{4}\right)^2 \rightarrow L = 30 \mu\text{H} \quad (33 \mu\text{H})$$

$$C = \frac{30 \mu\text{H}}{2} \left(\frac{0.707}{4}\right)^2 = 468,5 \text{ nF} \quad (470 \text{ nF})$$

There is one parameter more to set, is the maxim current that allows the inductance, and the max voltage that allows the capacitor.

$$I_{LMax} = \frac{5V}{8\Omega} = 0.625 \text{ A}$$

$$V_{CMax} = 5V$$



## 4. SYSTEM IMPLEMENTATION DOCUMENTATION

- Final schematics:

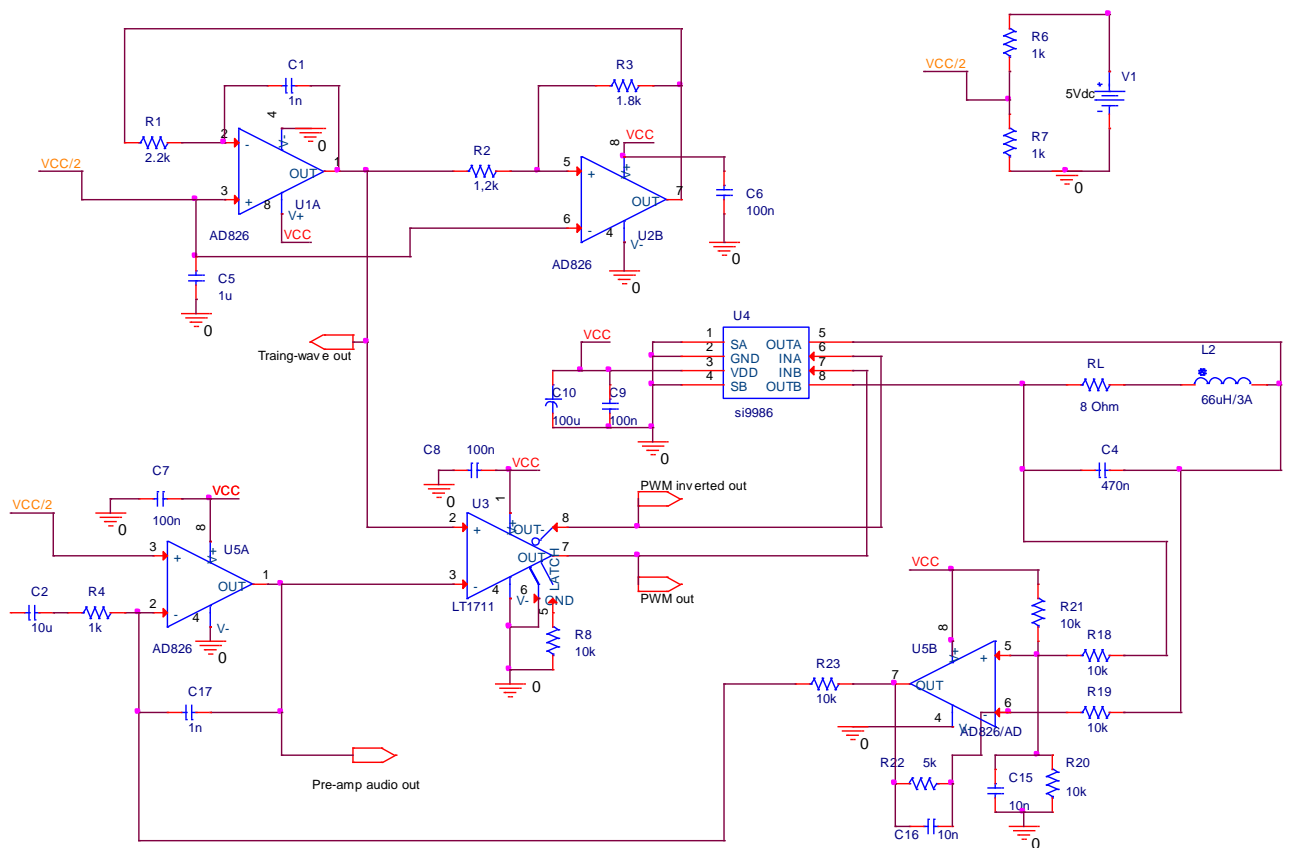



**- Circuit pictures:**

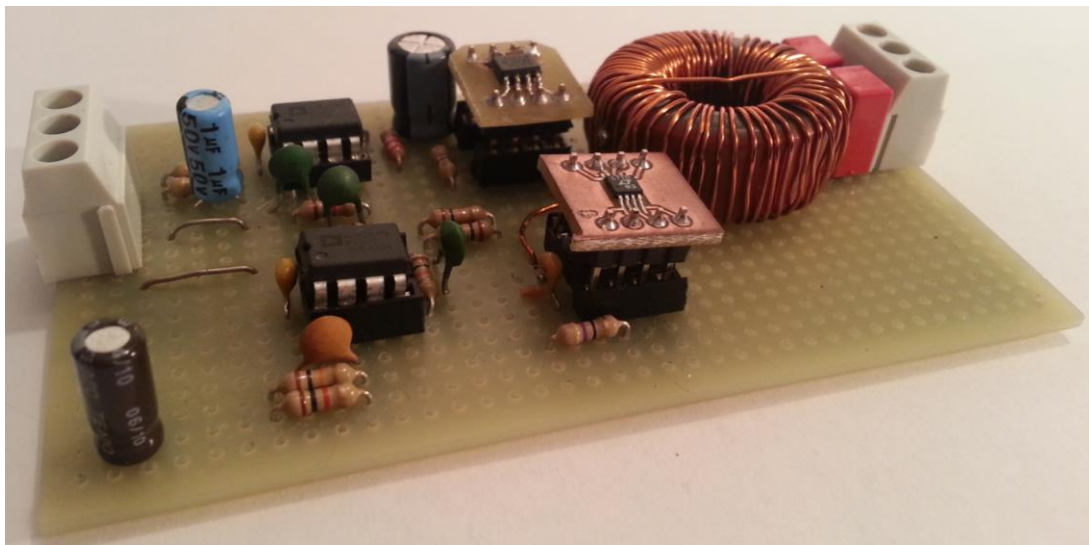
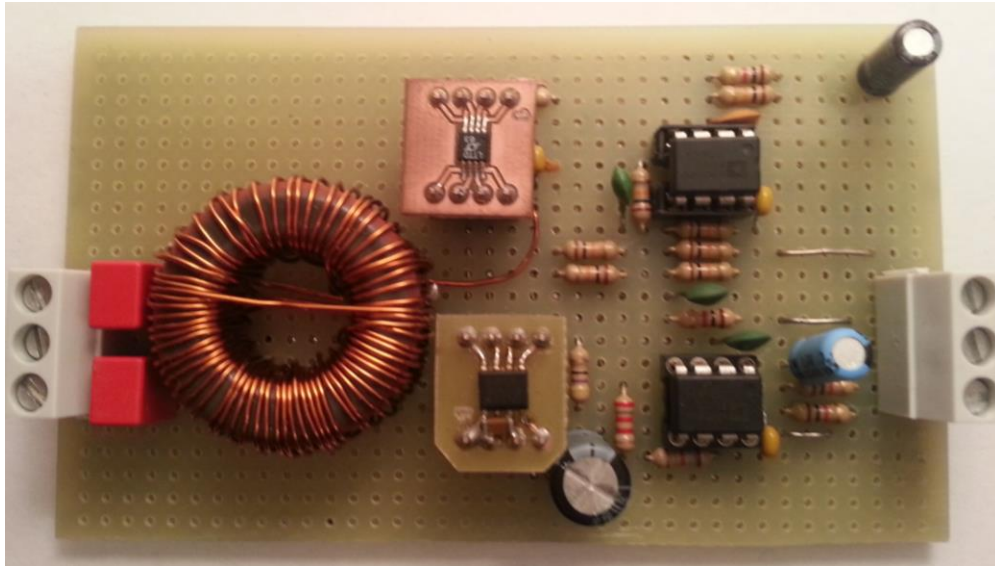





**- Frequency Response Virtual Instruments Matlab scripts:**

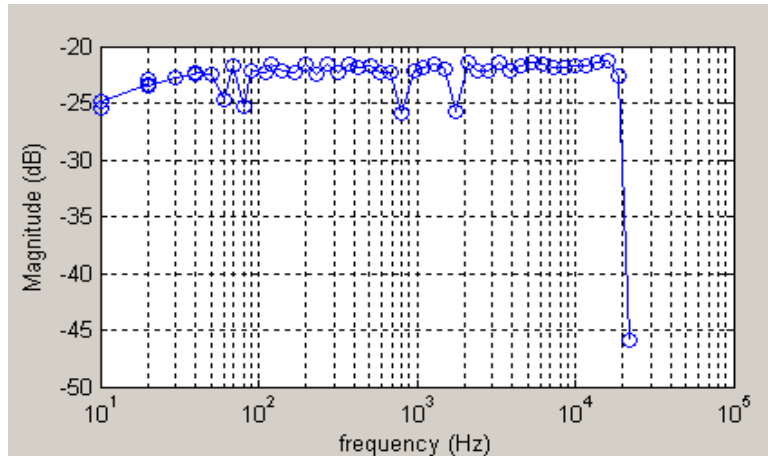

As we can see at the above graph, there are some points with big deviation, this points were in different point in other realizations, so we suppose there is some trouble with the script or data acquisition. For this reason we decide to measure manually th frequency response.

freq(Hz)	Vpp	20log(Vpp)
10	3,7	11,36403448
20	4,4	12,86905353
50	4,8	13,62482475
100	4,9	13,8039216
120	5	13,97940009
150	4,8	13,62482475
500	4,92	13,83930206
1000	4,8	13,62482475
1200	4,8	13,62482475
1500	4,8	13,62482475
2000	4,7	13,44195716
5000	4,6	13,25515663
10000	4,7	13,44195716
12000	4,8	13,62482475
15000	4,9	13,8039216
20000	4,8	13,62482475
30000	4,5	13,06425028
50000	3,9	11,82129214
100000	2,4	7,604224834

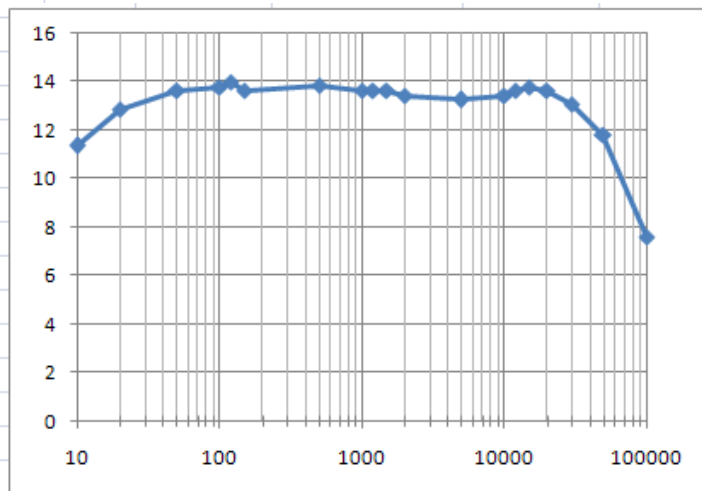

THD measure was not correct on Matlab script, so we make use of a low frequency spectrum analyzer with the following results:

Principal harmonic: 115.6 mV

Second harmonic: 1.28mV

Third harmonic: 0.19mV

We measure only the first three harmonics due to there were the most relevant.

The result of the measure of THD was: 1.57%

## 5. SYSTEM CHARACTERIZATION

Measurement set-up is referred at Verification protocol document.

The below chart show final measurements and results.

	Conditions	Symbol	Min	Typ	Max
<b>Output power</b>	VCC=6V, THD< 1.5%, RL=8Ω, Vin=200mVpp @ 1KHz	P <sub>o</sub>	0.9	1.15	1.57
<b>Energetic efficiency</b>	VCC=6V, THD<1.5%, P <sub>o</sub> =1.15W	η	76%	81%	88%
<b>Frequency response</b>	VCC=6V, Hz @ ±3dB		10Hz to 50KHz		
	VCC=6V, Hz @ ±1dB		20Hz to 30KHz		
<b>Total harmonic distortion + Noise</b>	VCC=6V, RL=8Ω, P <sub>o</sub> =1W	THD+N	1.5%		
<b>Signal to noise ratio</b>	VCC=6V f=1KHz, THD=1.5%	SNR	>80dB		
<b>Estimated cost</b>	Materials only		20.32€		
	Production 1000 units		9.38 €		

The final amplifier specifications don't fulfil all specifications of customer list, also all final specifications values are very similar to the customers ones.

To accomplish specification list exactly, is needed a greater invest of time and money.

We have done a study that makes see us how significant are the difference between the customer and final specification list.

To check the difference, we listen to an audio amplifier that accomplish the customer specification list, and then listen to our audio amplifier to notice the difference. So the result was that neither team can distinguish what of both audio amplifier was on.

## 6. BUDGET

### - COMPONENTS LIST

BLOCKS	Value	Number	Price (€)	Total(€)
<b>POWER SUPPLY</b>				
Voltage supply	6V	1	4,44	4,44
Resistences	1k	2	0,04	0,08
<b>TRIANGULAR SIGNAL GENERATOR</b>				
Resistences	1k2	1	0,04	0,04
	1k8	1	0,04	0,04
	2k2	1	0,04	0,04
Capacitor	1n	1	0,11	0,11
	100n	1	0,13	0,13
Amplifier	AD826	1	2,58	2,58
<b>INPUT FILTER AMPLIFIER</b>				
Resistences	1k	2	0,04	0,08
Capacitor	100n	1	0,13	0,13
	10u	1	0,16	0,16
Amplifier	AD826	1	2,58	2,58
<b>SIGNAL COMPARATOR</b>				
Resistences	10k	4	0,04	0,16
	47k	4	0,04	0,16
Capacitor	1n	1	0,11	0,11
	100n	1	0,13	0,13
	4.7u	1	2,2	2,2
	10u	2	0,16	0,32
Comparator	LT1711	1	1	1
<b>POWER BLOCK</b>				
Buffered H-bridge	si9986	1	3,2	3,2
Capacitor	100n	1	0,13	0,13
	100u	1	0,5	0,5
<b>LOW PASS FILTER</b>				
Capacitor	470n	1	0,5	0,5
Coal	66u	1	1,5	1,5
				<b>20,32</b>

- TEAM LIST AND COST

PRICE(€/h) 20

WEEK	INITIATION	FINAL	CLASS TIME (h)	JULIAN, EVA		LABELLA, CARLOS		
				TIME OUT OF CLASS(h)	TOTAL (h)	TIME OUT OF CLASS(h)2	TOTAL (h)	
1	09/10/2013	15/10/2013	3	2	5	1,5	4,5	
2	16/10/2013	22/10/2013	3	2,5	5,5	1	4	
3	23/10/2013	29/10/2013	3	2	5	1,5	4,5	
4	30/10/2013	05/11/2013	3	2	5	2	5	
5	06/11/2013	12/11/2013	3	2	5	3	6	
6	13/11/2013	19/11/2013	3	2	5	4	7	
7	20/11/2013	26/11/2013	3	3	6	1,5	4,5	
8	27/11/2013	03/12/2013	3	3	6	4	7	
9	04/12/2013	10/12/2013	3	4	7	4	7	
10	11/12/2013	17/12/2013	3	4	7	4	7	
11	18/12/2013	24/12/2013	3	4	7	4	7	
			<b>33</b>	<b>30,5</b>	<b>63,5</b>	<b>30,5</b>	<b>63,5</b>	
			<b>TOTAL COST:</b>		<b>1270</b>	<b>TOTAL COST:</b>		<b>1270</b>

WEEK	INITIATION	FINAL	CLASS TIME (h)	MARIMON, JOAN		ROMERO, ADRIA		
				TIME OUT OF CLASS(h)3	TOTAL (h)	TIME OUT OF CLASS(h)5	TOTAL (h)	
1	09/10/2013	15/10/2013	3	2	5	1	4	
2	16/10/2013	22/10/2013	3	1	4	2	5	
3	23/10/2013	29/10/2013	3	2	5	1	4	
4	30/10/2013	05/11/2013	3	3	6	3	6	
5	06/11/2013	12/11/2013	3	3	6	2	5	
6	13/11/2013	19/11/2013	3	3	6	3	6	
7	20/11/2013	26/11/2013	3	4	7	2	5	
8	27/11/2013	03/12/2013	3	4	7	4,5	7,5	
9	04/12/2013	10/12/2013	3	2	5	4	7	
10	11/12/2013	17/12/2013	3	5	8	5	8	
11	18/12/2013	24/12/2013	3	1,5	4,5	3	6	
			<b>33</b>	<b>30,5</b>	<b>63,5</b>	<b>30,5</b>	<b>63,5</b>	
			<b>TOTAL COST:</b>		<b>1270</b>	<b>TOTAL COST:</b>		<b>1270</b>

**TOTAL COST OF THE TEAM : 5080**

Document: Final_Report.pdf	<b>Final Report ASS – Ice Amp</b>	
Date: 03/12/2013		
Rev: 01		
Page 21 of 22		

## 7. CONCLUSIONS

In conclusion to our project called Ice Amp related with the company Amplifier, we have to say that since the project got started, the main purpose of the team was to create an audio amplifier that fitted the specifications of the main block project.

Above all, the amplifier would receive an analog audio signal from a PC and it would be able to amplify it and make it sound through a speaker. In order to do that, we had chosen the class D switched audio amplifier to make it possible. The differences between this class and A, B, A-B classes are its high efficiency (between 80 and 90 per cent), its relative low signal distortion and, as a disadvantage for the project, its high complexity.

The amplifier requirements for these reasons would be 2W over 8  $\Omega$  output power, around 80% efficiency, from 20 Hz to 20kHz signal noise ratio and a THD of 1%. Considering that, the estimated cost of the amplifier prototype would be 25 € but this Price would fall up to 10€ with a production of one thousand.

The first step to start up our project would be to spread the parts of the amplifier: D class PWM, power stage, low-pass filter and speaker. Then, the next step was to calculate the amplifier basic parameters with Matlab, and reached that point, we had to export to a physical protoboard.

During this term, we notice that the output signal was not the same as we want due to errors of each sub block, so we had to revise one by one taking care of which values it had to be.

Finally, we had all the blocks joined correctly and the output signal was perfectly amplified without almost distortion. The last step was to connect the amplifier at the input signal of the computer and the output at the speaker. The test sound was excellent.

In order to improve our amplifier, we had reduce the noise added by the comparator and some tolerance of the components, incorporating a feedback loop between input and output.

Initially, we receive of the customer a component list that we may use for elaborate the project. The project was developed in base of the component list provided to us.

While we were evaluating final performance of the audio amplifier, we realized that some components met specifications much greater than we need. So as conclusion, we can say that with some other simple components, our project could improve obtained results.

Document: Final_Report.pdf	<b>Final Report</b> <b>ASS – Ice Amp</b>	
Date: 03/12/2013		
Rev: 01		
Page 22 of 22		

## 8. REFLECTION DOCUMENT

Organizers have done a good work, during sessions they were there to answer doubts and their explanations were, in general, good.

The team could have been more organized. Sometimes all the team was doing the same thing so with a bit more of organization during the lab sessions we could have obtained similar results spending less extra time.

Our performance as a work team was good. Tasks were distributed equally and each member has done a similar amount of work. In general we could say that there was a good atmosphere in the team.

We are satisfied with the project. Our amplifier fulfills the specifications and we achieved it respecting, as much as possible, the initial choice of components and voltage supply, despite we had a lot of troubles with the comparator. But we are a bit disappointed because at the end we haven't had time to design and assemble the amplifier in a PCB.

We may not get the mark we set as goal because our expectations were too high, but we think that we have done a good job and we will get a good mark.